

### COLLEZIONE LUCI E RIFLESSI

La collezione per il bagno LUCI E RIFLESSI presenta una ricca gamma di specchi e sistemi di illuminazione coordinati. L'uso di TECNICHE e materiali innovativi ed un DESIGN rigoroso offrono soluzioni di grande funzionalità e alto gusto.

**'Un viso illuminato completamente - un trucco sempre perfetto'** OML in collaborazione con METAL LUX ha realizzato delle specchiere per il bagno con un nuovo sistema a calamita di illuminazione che permette di spostare i faretti nella posizione desiderata solo con le mani senza l'utilizzo di nessun attrezzo. Il sistema è a norma CE, l'impianto è a 12 Volt

### LUCI E RIFLESSI COLLECTION

The Bathroom's collection LUCI E RIFLESSI shows a rich range of mirrors and systems of lighting coordinated. The use of TECHNIQUES, new materials and a precise DESIGN offers a functional and refined solutions.

**'A completely brighten face, a perfect make-up'**

OML with METAL LUX has realized bathroom's mirrors with a new lighting magnet system that permit you to move the light in any position you want only with a hand and without any tools. CE – Norm, 12 Volt.

### COLLECTION LUCI E RIFLESSI

La collection pour le bain LUCI E RIFLESSI présente une riche gamme de miroirs et de systèmes d'illumination coordonnés. L'emploi de TECHNIQUES, de nouveaux matériels et d'un raffiné DESIGN offre solutions fonctionnelles et de grand goût.

**'Un visage tout éclairé, un parfait make-up'**

OML avec la collaboration de METAL LUX a réalisé des miroirs pour le bain avec un nouveau magnéto système qui permet de déplacer les lumières où on désire seulement avec la main et sans l'emploi d'aucun outil. CE – norme, 12 Volt .

### KOLLEKTION LUCI E RIFLESSI

LUCI E RIFLESSI, eine reiche Kollektion von Spiegeln und Leuchten fürs Bad mit innovativen Lösungen, neuen Materialien und ausgefeilter Technik. Hoher Design-Anspruch kombiniert mit absolut funktionsgerechtem Gebrauch.

**'Ein optimal ausgeleuchtetes gesicht - ein perfektes make-up'**

OML präsentiert in Zusammenarbeit mit METAL LUX ein neues Beleuchtungssystem fürs Bad. Mit der Hand lassen sich die Leuchtkörper versetzen, ganz nach Wunsch und Bedürfnis. CE-Norm, 12 Volt

### COLECCIÓN LUCI E RIFLESSI

**El rostro iluminado completamente, un maquillaje perfecto: ésto es lo que quieren las clientes.**

Hoy en día OML le corresponde a estas exigencias produciendo espejos con una técnica de iluminación totalmente móvil, una colaboración innovativa con Metal Lux, empresa líder en el sector de la proyectación y producción de equipos de alumbrado. Dicho nuevo sistema consiente mover a gusto y a discreción del cliente, el grupo de alumbrado por encima, por el lado del espejo, y a la inversa sin usar utensilio alguno, solamente con las manos, y sin peligro alguno para las persona. Ello es posible porque el grupo de alumbrado está alojado encima de un marco equipado con unas calamitas que consienten mover el espejo como uno quiere. La instalación es de 12 V. Además ... un amplio programa de iluminación con espejos, apliques y plafones. El catálogo específico permite una consultación clara para una elección segura, personalizada y coordinada.



LUCI E  
RIFLESSI



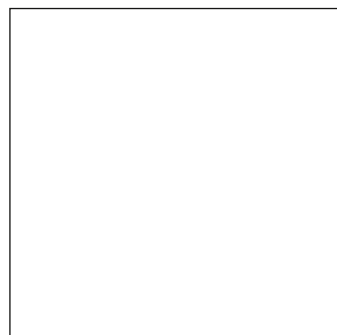
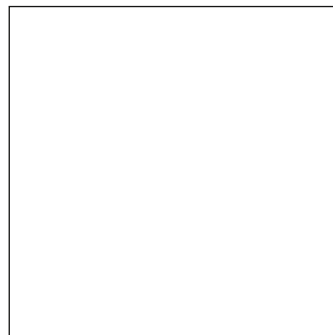
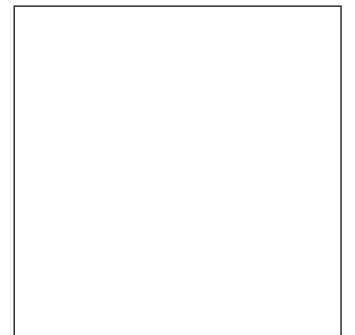

# LUCI E RIFLESSI

**L454L VEN**  
cornice massello colore vengé  
mirror with wooden frame in wenge  
bay oak colour



1



2

**1. L455L ROV**

cornice massello rovere

mirror with wooden frame in pale bay oak colour

**2. L412L**

cornice cromata

mirror with chromed frame



LUCI E  
RIFLESSI

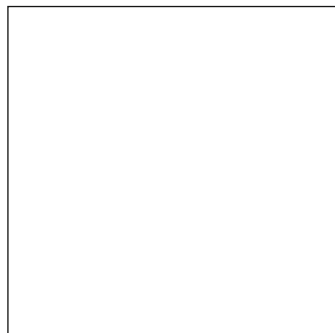
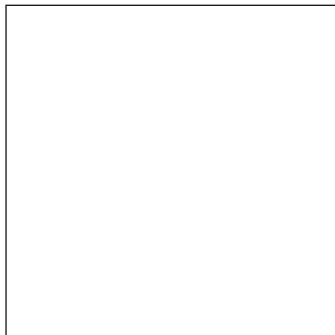

# LUCI E RIFLESSI



**1. 1402L**  
specchio con applique con 2 lampade 20W a  
12 Volt con trasformatore  
*mirror with 2 lamps applique 20W each - 12V*

**2. 1403L**  
specchio con applique con 1 lampade 40W  
*mirror with 1 lamps applique*





# LUCI E RIFLESSI

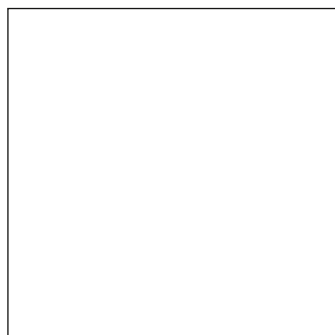
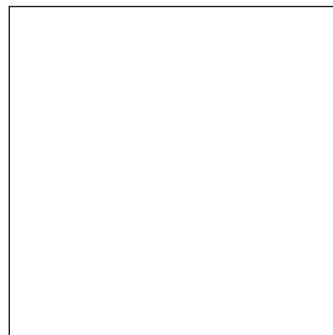

**1. 1307**  
specchio con bisellatura anteriore  
ad effetto cornice  
*mirror with frame-like front chamfering*

**2. 1304**  
specchio con bisellatura anteriore  
ad effetto cornice  
*mirror with frame-like front chamfering*



1

**1. 1309L**

specchio con bisellatura posteriore argentata ad effetto cornice ed appliques alogene a bassa tensione  
*mirror with rear frame-like silver-plated chamfering and low-voltage halogen lamps*

**2. 5012A2**

specchio con bisellatura e appliques ad incandescenza  
*mirror with chamfering and incandescent lamps*

**3. 1308**

specchio con bisellatura  
*mirror with chamfering*



2



3

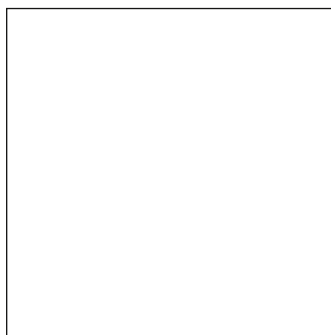

# LUCI E RIFLESSI



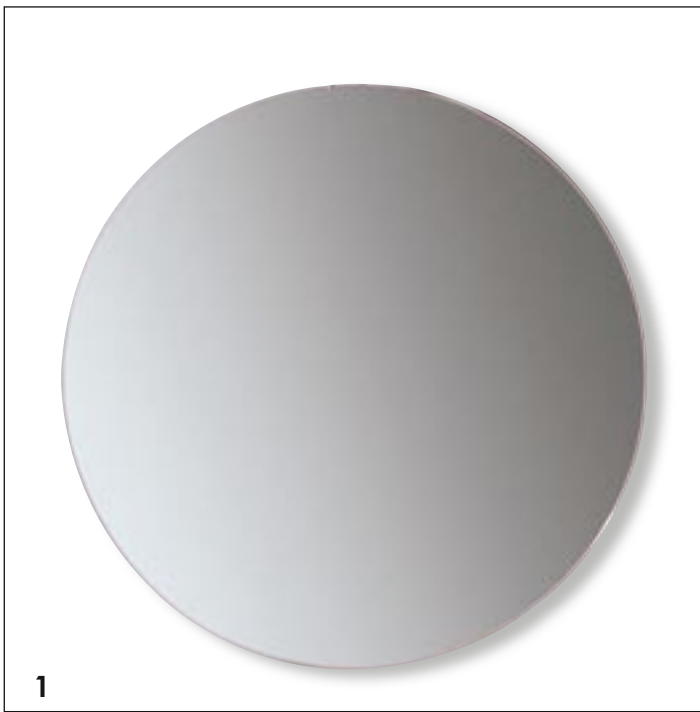

# LUCI E RIFLESSI

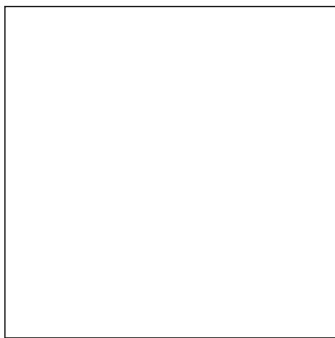

**1. 1012**  
specchio  
*mirror*

**2. 1306**  
specchio con cornice in vetro satinato  
*mirror with satin-finish glass frame*

**3. 9012**  
specchio  
*mirror*



**1. L612L**

specchio con applique alogena a bassa tensione  
*mirror with low-voltage halogen lamp*

**2. 4012L6**

specchio con applique alogena a bassa tensione  
*mirror with low-voltage halogen lamp*

**3. L212L**

specchio con applique alogena a bassa tensione  
*mirror with low-voltage halogen lamp*

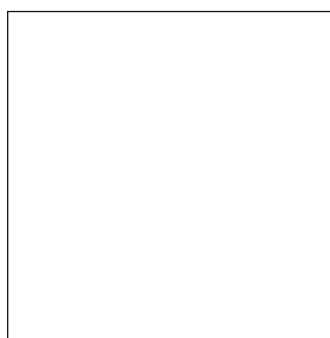

# LUCI E RIFLESSI



1



2

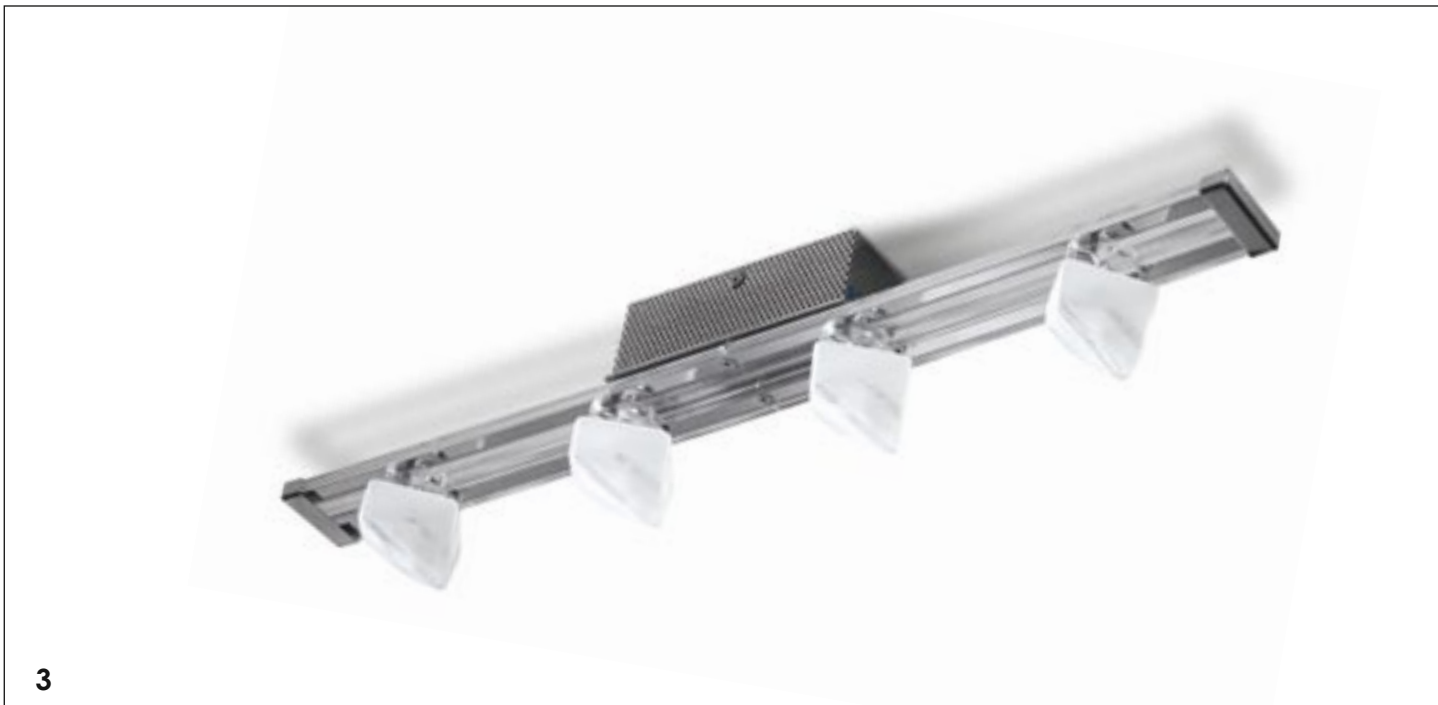

3

# LUCI E RIFLESSI

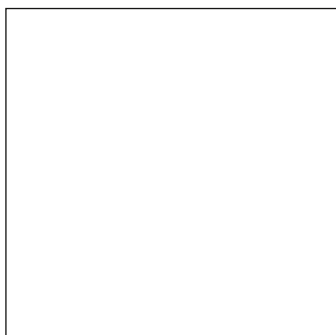

**1. 1433**  
plafoniera con diffusore sabbato Pirex con 1  
lampada alogena  
*halogen ceiling light with diffuser  
in sanded Pyrex*

**2. 1432**  
plafoniera con due diffusori in vetro Pirex  
sabbato trasparente con 4 lampadade alo-  
gene G9  
*halogen ceiling light composed of 2 diffuser  
in sanded/transparent Pyrex and 4 G9 lights*

**3. 1430**  
plafoniera con faretto a calamita e lampada  
alogenahalogen ceiling light  
*with magnetic lights*

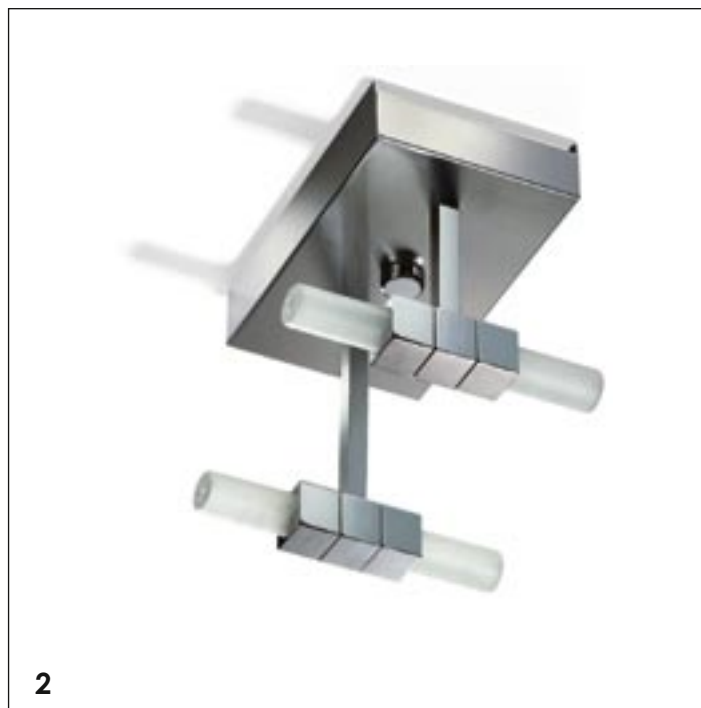

**1. 1183**  
plafoniera  
*ceiling lights*

**2. L210**  
plafoniera alogena  
*halogen ceiling*

**3. 4010**  
plafoniera alogena  
*halogen ceiling*

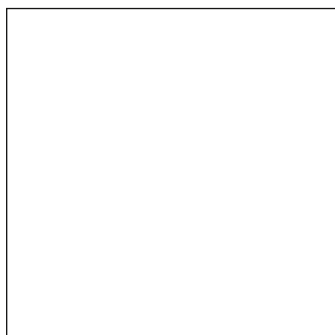

# LUCI E RIFLESSI



**1. L610**  
plafoniera alogena  
*halogen ceiling*

**2. 1191**  
plafoniera  
*ceiling lights*

**3. 1194V**  
plafoniera  
*ceiling lights*

**4. 1195S**  
plafoniera  
*ceiling*

# LUCI E RIFLESSI

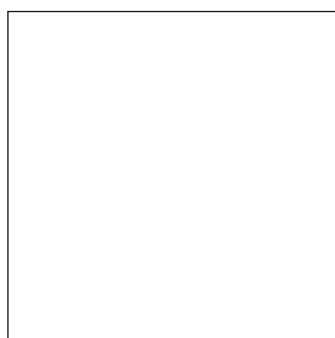



**1. L611**

applique fissate allo specchio  
*lamps fixed to the mirror*

**2. L211**

applique fissate allo specchio  
*lamps fixed to the mirror*

**3. K2016B**

applique fissate allo specchio  
*lamps fixed to the mirror*

**4. 688 CROMO**

applique fissate a parete  
*lamps*

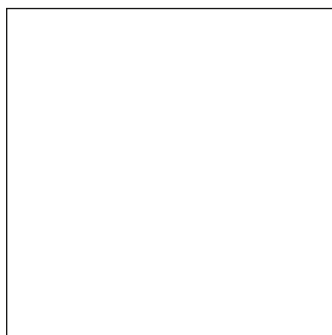

**LUCI E  
RIFLESSI**



# LUCI E RIFLESSI

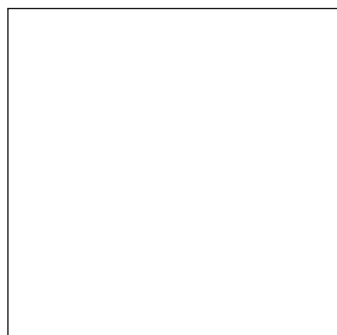

**1. 1196V**  
appliques fissate allo specchio  
*lamps fixed to the mirror*

**2. 1166**  
appliques fissate allo specchio  
*lamps fixed to the mirror*

**3. 1197R**  
appliques fissate allo specchio  
*lamps fixed to the mirror*

**4. 311**  
appliques fissate allo specchio  
*lamps fixed to the mirror*



**1. 311P**  
applique a parete  
*wall-lamps*



**2. 1197PR**  
applique a parete  
*wall-lamps*



**3. 1196PB**  
applique a parete  
*wall-lampsr*

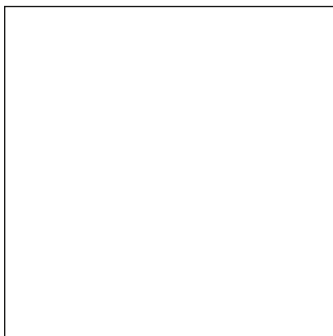

# LUCI E RIFLESSI



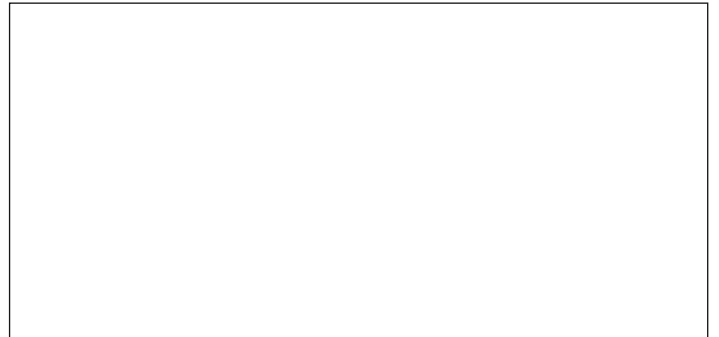

**1. 1184**  
applique a parete  
*wall-lampsr*

**2. 4011**  
applique a parete  
*wall-lampsr*

# LUCI E RIFLESSI

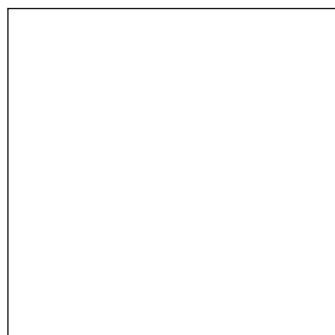



**Art. P1012A** Specchio con applique Ø60

**Art. P1012A** Mirror with lamp Ø60



**Art. P913L** Specchio con applique e ingranditore girevole Ø52

**Art. P913L** Mirror with lamp and magnifying rotating mirror Ø52



**Art. P912** Specchio bianco Ø35  
**Art. P912** White mirror Ø35



1

**1 Art. G256** Applique per specchio cm. 50  
**1 Art. G256** Lamp for mirror cm. 50



2

**2 Art. G255** Applique per specchio Ø12  
**2 Art. G255** Lamp for mirror Ø12

